

Installation Instructions

Luxury Vinyl Tile & Plank - Glue Down

2TWELVE, 3TWENTY, VOYAGER & TIMES SQUARE



CERTIFIED BY
SCS Global Services



Attention

Before starting installation, read all instructions thoroughly. Should any questions arise, please contact your local Hallmark Floors dealer or phone Hallmark Floors direct at 888 551 0888. Instructions are available at www.hallmarkfloors.com. Instructions are also available via cell phone. All installation instructions must be followed for warranties to be considered valid. Pre-inspect the job site prior to delivery of the floor to ensure the structure is suitable for luxury vinyl flooring installation using the following guidelines

Owner/Installer Responsibility

1. Inspect all materials carefully prior to installation. Warranties do not cover materials with visible defects once they are installed. Installation constitutes acceptance.
2. Inspect the luxury vinyl flooring in well lighted conditions to ensure proper identification of any potential problems. Carefully inspect the flooring for grade, color, finish, and quality. If the flooring is not acceptable, contact Hallmark Floors' distributor and arrange shipment of replacement material. Defective product will be replaced. Material that is subjectively viewed as unacceptable but falls within Hallmark Floors' grading norms will not be replaced.
3. Prior to installation of any flooring, the installer must ensure the job site and sub floor conditions meet the requirements specified in these instructions.
4. Luxury vinyl flooring installation should be one of the last items completed on the construction project. Limit foot traffic on the finished luxury vinyl plank/tile.

Storage & Handling

Handle and unload luxury vinyl flooring with care. Store in a dry place. Make sure to provide at least a 4" space (a dry pallet with a solid plywood top that provides enough clearance under boxes for proper air movement). Prior to delivery of flooring, outside doors and windows must be in place. All concrete, masonry, plastering, and other "wet" work must be complete and thoroughly dry. Roofing and the exterior shell of the structure must be finished and weather tight with doors and windows installed. The wall coverings should be in place and all painting completed—except for the final coat on the base molding. Room temperature and humidity should be consistent with year-round conditions for at least one week prior to installation. When possible, install base molding after floor installation is complete. Flooring should be stored and installed in climate constant or climate controlled indoor location 65°F TO 85°F and between 30 to 50% relative humidity. Product and adhesives must be acclimated to a living condition environment for 48 hours prior to installation.

***ATTENTION:** Exposure to sunlight and other heat sources may affect the performance and installation of the floor.

Pre-Installation Inspection Visual Inspection

The first inspection is visual and basic. Is there visible moisture present? Are there uncovered South/West facing windows or sliding glass doors?

Climate Control

If heating and/or air conditioning with proper humidity controls are in operating condition, they need to be turned on. If it is not possible for the permanent system to operate, a temporary system that provides proper temperature and humidity conditions must be in place and remain in place until permanent climate and humidity control is operational. Temperature of 65°-85°F must be maintained.

Install Flooring Last

Luxury vinyl should be the last trade in the house (before base boards are installed). All concrete, masonry, plastering/drywall, texturing, and painting primer coats are completed. Do not install in direct sunlight.

Covering the floor while wet trades are in the house is not recommended. Moisture can pull into the paper or be trapped under the surface of materials used to cover the floor. Paper coverings also allow dents and scratching to occur. Coverings held in place for more than 24 hours by blue tape can damage the floor.

Hallmark Floors recommends that built-in cabinets and built-in furniture be installed before installation of the floor. This prevents damage to the flooring and makes potential flooring repairs simpler to perform.

Exterior Checks

1. Is exterior soil elevation 6" below edge of flashing?
2. Does exterior slope away from foundation at a rate of 6" drop in 10' for soft-landscaped areas and 3" drop in 10' for hard-paved areas?

NOTE: Proper drainage away from the structure is absolutely critical to ensure weather-tight conditions and crucial to proper luxury vinyl flooring performance.

If structure is near a hill, the lot should be graded with a swale to move moisture off the lot and prevent it from coming in contact with the foundation.

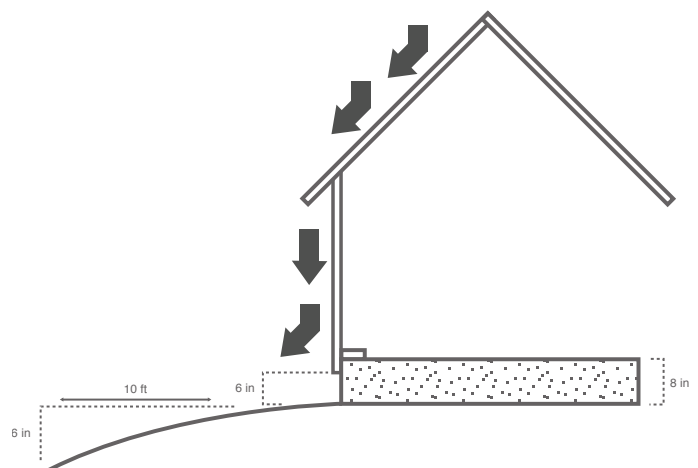

Crawl Space Ventilation

Crawl space earth (or thin concrete slab) should be covered 100% by a vapor retarder of black polyethylene (minimum 6 mil) or any recommended puncture-resistant membrane, such as Class C meeting ASTM D1745. Check local codes for any additional requirements.

Size of available vents should equal to 1.5% of the square footage within the crawl space. Relative humidity should be consistent with interior of home. Moisture content of sub floor should not vary more than a 2% MC from the top of the sub floor to the bottom.

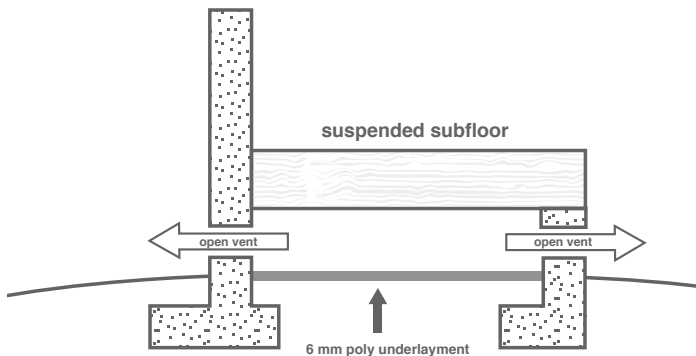

It may be necessary to install temperature/humidity activated exhaust fans to create more air movement in the crawl space. Uncontrolled humidity and moisture in crawl space will lead to mold and damage to the structure, as well as the luxury vinyl floor. In these events, a contractor specializing in dehumidifying systems will need to be contracted to keep crawlspace humidity within proper norms. This is more likely in high humidity areas. Ensure that clothes driers are properly vented to the outside of the foundation. Check for signs of plumbing, both pressurized and non-pressurized/drain leaks.



NOTE: Completely sealed crawlspaces (no exterior cross-ventilation) require a dehumidification system as part of the sealed crawlspace design.

Basement Moisture & Humidity Control

Basements should be completely weather tight and have proper drainage away from the foundation walls in place to ensure that the basement remains dry.

1. Rain gutters must be in place to carry moisture away from the house. French drains are recommended, and basement walls should be properly sealed.
2. Relative humidity of basements should not be more than 10% higher than the upper floors.
3. Humidity control of the basement is vital to help control mold and prevent damage to the structure and luxury vinyl flooring.
4. Basement walls should be inspected for cracks and excessive moisture content.
5. Drains must be placed at basement windows.
6. Direct sprinklers and irrigation systems away from the foundation. Sprinklers spraying the foundation edge can lead to moisture intrusion into structure. Drip irrigation systems for plant beds is recommended.

Sub floor Moisture Testing CONCRETE

ROLLER APPLICATION: Up to 18 lbs. on a Calcium Chloride Test and up to 97% RH (In-Situ Probe).

Up to 25 lbs. on Calcium Chloride.

Test and up to 100% RH (In-Situ Probe).

Hallmark Floors does not offer a moisture warranty against moisture related issues or related damage under warranty. (See Hallmark Floors Maintenance & Warranty Guides).

NOTE: Due to the porous nature of concrete, vapor emissions are subject to change over the lifetime of the installed floor. Slab moisture emissions are a common cause of damage to vinyl floors. Due to the potential for concrete moisture emissions to increase/decrease over time, and the absence of moisture warranties for vinyl flooring, using an adhesive manufacturer moisture abatement system following NWFA standards. Some adhesive manufacturers offer adhesive/moisture abatement systems that do not require pre-installation testing of the slab to maintain a moisture warranty. Check with adhesive manufacturer to confirm they offer products that allow installation without pre-checking/testing the slab.

ADDITIONAL NOTE: Hallmark Floors makes no guarantees regarding the performance of any adhesive/vapor abatement system.

The installer is fully responsible for proper installation, and the moisture warranties are fully the responsibility of the adhesive moisture abatement system manufacturer chosen for the job.

Industry Standards

Industry standards use the following test methods to determine optimal conditions for installation and performance of a hardwood floor. Some adhesive manufacturers offer systems that create a vapor barrier to protect the luxury vinyl and premium vinyl flooring from moisture emissions coming up through the slab. Many adhesive manufacturers require the below listed tests to be performed prior to installation of the floor: Carefully read and follow the adhesive manufacturers instructions.

CALCIUM CHLORIDE: ASTM F1869

Under ideal conditions, the slab should not be emitting more than 3 lbs. per 1,000 square feet per 24 hour period. Carefully follow the instructions in the test kit to ensure that you get accurate results.

NOTE: The slab emissions can vary based on soil humidity and room temperature. Consult adhesive manufacturer's directions for the moisture abatement system they recommend.

HUMIDITY PROBE & DIGITAL METER: ASTM F2170

Widely used in Europe, this test determines the amount of humidity in the slab. This is an effective way to determine a slab's potential for emitting moisture. Follow all meter manufacturer's guidelines for performing testing. Under ideal conditions, the slab readings should be 75% RH.

CAUTION: Post Tension slabs require special care to avoid cutting cables in slab. Cutting post tension cables can cause serious structural damage and potential fatalities.

New concrete slabs require a minimum of 60 days drying time before covering them with a luxury vinyl or premium vinyl floor. The slab must be fully cured. Slab must be comprised of Portland-based mix with 2,500 PSI of compressive strength.

Sub floor Preparation CONCRETE

For glue down application over gypsum or lightweight concrete, the same 2,500 PSI rating is required.

Note: Some adhesive systems have primers and adhesives that are suitable for use over gypcrete or lightweight concrete, and may have different PSI compressive strength requirements.

Adhesive manufacturer is responsible for performance of their systems over gypcrete or lightweight concrete.

Remove all paint, oil, existing adhesives, wax, grease, dirt, sealers, and curing compounds. Do not use solvent-based strippers under any circumstances because residual solvents can prevent the satisfactory bonding of the vapor barrier and adhesive systems. It is important to ensure a long lasting bond between the adhesive, the concrete, and the boards.

All sub floors must be clean, smooth, and flat within 3/16" in a 10' radius or 1/8" within a 6' radius. Dust, scale, old adhesive, and asphalt cut-back adhesive must be removed.

CAUTION: Test cut-back adhesives for asbestos content. If the cut-back contains asbestos, contact an asbestos abatement company for professional removal.

The surface must be free of paint, grease, drywall, curing/sealing compounds, existing resilient floors, engineered hardwood floors, wax, oil, alkali and any other foreign material that would negatively affect the bonding of the adhesive.

Use sanding system with 20 grit # 3-1/2 open-face paper to remove loose, flaky concrete. For heavy surface contamination, it may be necessary to bead-blast the concrete surface.

Sub floor tolerance for a flat surface is 3/16" within a 10' radius and 1/8" in a 6' radius. These are widely accepted industry standards. Use a straight edge to determine if sub floor requires grinding or filling.

Surface of the concrete floor should be similar to light broom finished concrete before proceeding with installation.

All sub floor patching and leveling should be done with a quality, water resistant, non-shrinking Portland cement patch. Concrete floor must be smooth and flat to prevent telegraphing imperfections in the concrete. NOTE: Be sure to use Portland based patch and levelers on Portland based slabs and Gypsum for Gypcrete. Follow all manufacturer's guidelines for those products.

Wear appropriate NIOSH designated dust mask to reduce risk of dust inhalation. Wear proper eye protection and avoid prolonged contact with eyes and skin. In the event of eye irritation flush with water for 15 minutes and seek medical attention!

Hallmark Floors is not responsible for any movement in expansion joints in concrete slab, nor any performance issues related to the sub floor.

CAUTION: ASBESTOS

State and Federal agencies have determined that asbestos is a respiratory carcinogen. Avoid sanding or scraping of old vinyl, linoleum, and VCT as they may contain asbestos. Take proper precautions and contact an asbestos abatement company to remove any old vinyl or vinyl tile floors containing asbestos. Cut-Back adhesive and other types of adhesives can also contain asbestos.

Do not sand, sweep, dry or wet scrape, mechanically chip, bead blast, or pulverize existing resilient flooring, the felt, lining, paint, black asphalt cutback adhesives, or other existing adhesives. These products could contain asbestos fibers or crystalline silica.

Breathing dust from these sources increases your risk of cancer and respiratory diseases. If you smoke and are exposed to asbestos fibers, you are at greater risk of serious damage to your health.

If you are not sure that the product being removed is asbestos free, assume that the product contains asbestos or crystalline silica. Regulations in your area may require you to have the material tested to determine if it contains asbestos. Check the Resilient Floor Coverings Institutes' recommendations for removal of existing resilient floor coverings.

Chemical adhesive removal products must not be used to prepare the slab. Use of such chemicals will void the warranty on all Hallmark Floors products

Installing over Existing Floor Coverings on Concrete

Perimeter-glued resilient vinyl, VCT and rubber tiles are not acceptable underlayments and must be removed.

Sub floor Moisture Testing wood

Probe-type (pin) meters are considered the best method of testing. Remember: the top and bottom of the sub floor should vary no more than 2%. Wood substrates must have a moisture reading of no more than 12% when using Lignomat, Tramax, Delmhorst, or equivalent moisture meter, and be within 4% of the moisture content of the flooring to be installed.

Sub floor Preparation WOOD

1. Wood sub floors with a crawlspace must have a minimum of 18" between the bottom of the joists and the surface of the soil. Soil must be covered with 6-8 mil black plastic as vapor barrier. Plastic must be overlapped at joints by a minimum of 8 inches and fully taped with a high quality moisture-proof duct tape.
2. All sub floors must be clean, smooth and flat within 3/16" in a 10' radius and 1/8" in a 6' radius. Dust, scale, old adhesive, and asphalt cut-back adhesive must be removed. The surface must be free of paint, grease, drywall, curing/sealing compounds, existing resilient floors, engineered hardwood floors, wax, oil, alkali, and any other foreign material that would negatively affect the bonding of the adhesive. CAUTION: Test cut-back adhesives for asbestos content. If the cut-back contains asbestos, contact an asbestos abatement company for professional removal.
3. Solid Board Sub flooring should be 3/4" x 5 1/2" (1" x 6") group 1 dense softwoods (SYP, Doug Fir, Larch, etc.), #2 common, kiln-dried. Solid board sub flooring should consist of boards no wider than 6", installed on a 45° angle, with all boards ends full bearing on the joists and fastened with a minimum 8d rosin-coated or ring-shanked nails, or equivalent. Solid board sub flooring that is uneven at edges should be repaired and sheeted with 1/2" (15/32", 14 mm) Baltic Birch 1 plywood sub floor panels, 4' x 8' sheets, and should be installed running cross-truss/joist. Glue top and bottom layer together with construction adhesive and screw into the truss/joist system every 12". Additionally nail (ring shank) or staple layers together on a minimum 12" grid pattern.

4. Plywood/OSB Sub floors

- a. Truss/joist spacing of 16" (406cm) o/c or less, the industry standard for single panel sub flooring is a minimum of 5/8" (19/32", 15.1mm) CD Exposure 1 plywood sub floor panels or 23/32" OSB Exposure 1 sub floor panels, 4' x 8' panels. Place 6-9mm Baltic Birch plywood on surface.
- b. Truss/joist spacing of more than 16", up to 19.2" (488mm) o/c, the standard is a minimum 3/4" (23/32", 18.3mm) tongue and groove CD Exposure 1 plywood 4' x 8' sheets glued and mechanically fastened. Place 6-9mm Baltic Birch plywood on surface.
- c. Truss/joist spacing of more than 19.2" (488mm) o/c up to a maximum of 24" (610mm) o/c requires a minimum 7/8" tongue and groove CD Exposure 1 plywood sub floor panels, 4' x 8' sheets, glued and mechanically fastened, or nominal 1" OSB Exposure 1 sub floor panels glued and mechanically fastened –or two layers of sub flooring. Place 6-9mm Baltic Birch plywood on surface.

5. Joist Cross-Bracing

A sub floor that is not thick enough to support the span of the joists will cause unacceptable sub floor deflection. An alternative to adding additional plywood on top of the sub floor would be to cross-brace between the joists. The cross-bracing would be done at the appropriate distance on center to meet specification and bring the deflection within proper tolerance.

Check with the joist or truss manufacturer to determine if cross-bracing is allowed with that system. Should it not be compatible with the joist or truss manufacturer, sheeting the sub floor with a second layer of 9mm/ 3/8" Baltic Birch plywood would then be the only option.

DIRECTION OF INSTALLATION IN RELATION TO JOIST DIRECTION.

The best application is at a 90° angle across the joists. This provides for best stability of the floor. As an alternative, the floor can be installed at a 45° angle to the joists. The floor cannot be installed in the same direction as the joists without installing an additional sheet of plywood on top of the existing wood sub floor.

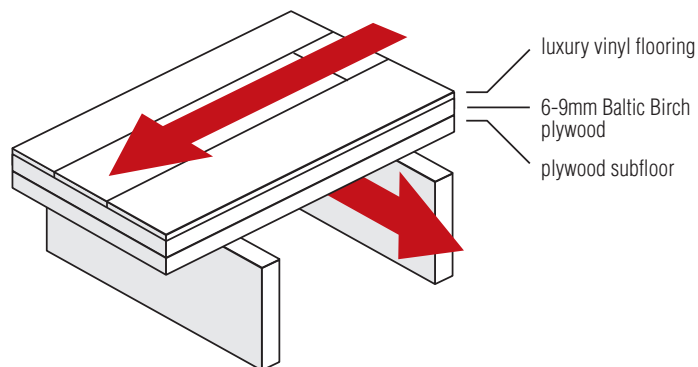

6. For Glue Down Application Sheet wood sub floor with minimum 6mm Baltic Birch Underlayment Plywood. Use 9mm if sub floor needs additional rigidity. Hallmark Floors does not warrant our products glued down to subfloor-grade plywood, particle board, O.S.B, Luan or Maranti types of underlayment.

6mm Plywood Underlayment Crossection



9mm Plywood Underlayment Crossection

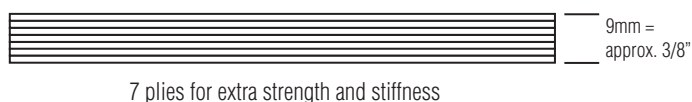

7. Make any repairs necessary to the existing sub floor prior to installing Baltic Birch plywood underlayment. CAUTION: Some nail types, i.e. common steel nails, can cause discoloration of the vinyl floor. Gluing down with construction adhesive and screwing plywood panels into joists can cause discoloration issues. Solvent-based construction adhesives can stain vinyl floor covering. Use of solvent free construction adhesives is therefore recommended to avoid floor stain issues. Hallmark Floors, is not responsible for discoloration of vinyl floor from adhesives used to secure Baltic Birch plywood underlayment to sub floor.

8. See Baltic Birch plywood underlayment manufacturer's specification/instructions for proper installation of product.
9. Stagger Baltic Birch plywood end joints and loosely butt edges per installation panel manufacturers installation instructions. Fastener holes and seams should be filled with a polymer modified patch. These products are applied in a thin skim coat per manufacturers instructions. Make sure to fill all end and side joint nail holes and dents in the underlayment to prevent transfer to the surface. Allow to dry completely.
Note: Remember, the patch may be ¼" deep or more in the joint between two panel edges. Not that it will not dry as quickly as a surface patch. When a latex adhesive is applied to the underlayment, some of the water is absorbed into the wood causing it to expand slightly. This expansion will force the wet patch out of the joint, forming a bead that can be seen through the vinyl.

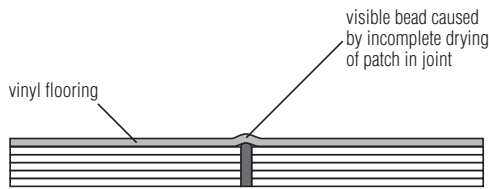

10. Lightly butt Baltic Birch plywood underlayment panel edges together. Do not force panels together, but do not leave a gap. Leave a minimum perimeter gap of ¼" and a maximum gap of ½" between the Baltic Birch plywood underlayment panel edges and the walls for expansion.
11. Cut Baltic Birch plywood underlayment panels as necessary and lay out factory edges to factory edges. Lay out any edges with jobsite cuts towards the wall. Make any long, straight cuts from the underside of the Baltic Birch plywood underlayment panel using a circular power saw with a fine toothed blade. Adjust the blade to extend no more than 3/8" through the Baltic Birch plywood underlayment to minimize splintering.

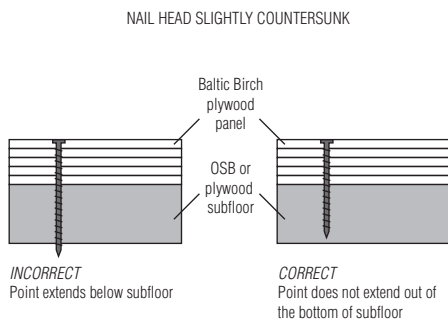

12. Selecting the Baltic Birch plywood underlayment fasteners:
Use plated ring shank underlayment nails with a 3/16" diameter head or double coated chisel point staples with a ¼" maximum crown. The fastener length should be selected so that the point will not extend through the bottom side of the sub floor. Do not use uncoated, cement coated, or rosin coated fasteners, as they may contribute to staining/discoloration. Ensure the panel is in firm contact with the sub floor. Always have your body weight on the panel being fastened.

13. All fasteners should be countersunk slightly below the surface of the new underlayment. Adjust air pressure on air staplers to a minimum to avoid staple blow through. Fill with feather patch approved for such use, allow to dry, and sand nail holes and joints to prevent telegraphing through surface of vinyl. Avoid over-sanding and cupping of joints.
14. Once the patch is dry, re-sand all areas with a low-speed rotary sander. If necessary, patch again, allow to dry, and re-sand with a low-speed rotary sander. Keep the underlayment clean and dry until luxury the vinyl flooring is ready to be installed. If necessary, cover Baltic Birch plywood underlayment with protective paper until ready to install luxury vinyl flooring.

Clean the Sub floor

After all prep work is completed, sweep and/or vacuum the sub floor. Dust and dirt can affect the adhesive's ability to adhere to the sub floor.



Other Substrates QUARRY TILE, TERRAZZO AND CERAMIC TILE.

Any embossing or grout joints need to be filled with a Portland-based cementitious patch. Substrates must be firmly attached to sub floor. Hallmark Floors makes no warranties in regards to performance or suitability of use of any sub floor or substrate. The surface must be sound, tight, and free of paint, oil, existing adhesives, wax, grease, and dirt.

Terrazzo and ceramic tile must be sufficiently scuffed to assure adhesion. Portland based cementitious levelers must be used to comply with flatness requirements of 3/16" in a 10' radius or 1/8" in a 6' radius. See adhesive/cementitious levelers manufacturer's guidelines.

Existing vinyl, tile, or terrazzo are not considered to be vapor barriers and can still transmit unacceptable moisture levels which can become trapped under a vinyl floor. This is true of both concrete and wood sub floors. Wood fibers, dust, drywall, latex paint, or other organic material under the floor can promote fungal growth, degradation of adhesives, and dimensional instability in the plank/tile. Therefore, preventing excessive moisture under the floor is critical.

Existing hardwood flooring must be remove prior to installation.

Luxury Vinyl Radiant Heat

All Radiant Heat systems must have failsafe capability to ensure surface temperatures do not exceed 80°F.

Lightweight Concrete/Gypcrete

1. The heating system tubes must be 1 ½" below the surface layer of the concrete slab/thermal mass.
2. 2-3 weeks prior to the installation the thermostat must be set at 70° F, then at 85°F for 3 days. The home should be aired out briefly every day to allow the excess humidity from the thermal mass to exhaust out of the structure.
3. The lightweight concrete moisture content must not exceed 1.5% as measured with a Tramax Moisture Encounter meter prior to installation.
4. Lightweight concrete/gypsum based thermal mass must have a minimum compressive strength of 2,500 psi. When gluing down see adhesive, see manufacturer's recommendations for compressive strength.

Wood Sub floor Systems With Aluminum Transfer Components

5. ALUMINUM HANGERS

Aluminum hangers must be .03125"/0.79mm to .0625"/1.58mm thick and have a minimum of ¾" sub floor. Hangers must reach joist to joist 16" to 19.2" on center, and have no gaps between sides and ends of aluminum hangers. A good system also contains insulation to prevent thermal loss and ensure even heating.

6. DECKING OVER SLEEPERS

Decking must be a minimum of ¾" thick with a minimum ¾" sub floor with an aluminum transfer sheet of .03125"/0.79mm to .0625"/1.58mm in thickness and attached to the bottom of the decking material. Sleepers should be 18" on center. In-floor heating systems must be water-based, low temperature, and must be designed to prevent surface temperature of the floor from exceeding 80° F. All glue down applications on wood sub floor assemblies must be sheeted with at least 6mm Baltic Birch plywood and prepped as described in these instructions.

7. No electric radiant heat systems are approved for use with Hallmark Floors 3Twenty, 2Twelve, Voayger and Times Square luxury vinyl flooring!!!

8. Passive radiant heat systems are not suitable for use with Hallmark Floors luxury vinyl flooring. Any approved radiant system must be combined with the ability to move the air in the room for proper heat distribution and to prevent excessive heat at floor level. Humidity controls must be in place to maintain relative humidity within a 30 to 55% RH range.

9. Surface-channeled radiant boards, are not acceptable for use under Hallmark Floors resilient flooring. A minimum of ¾" must be maintained between the vinyl floor and the water tubing. This is not possible with these types of systems. This applies to systems with or without an aluminum transfer sheet.

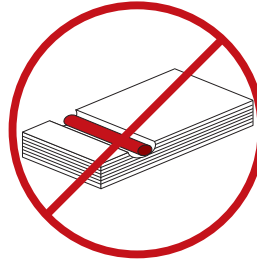

Sub floor level tolerances listed previously, also apply to radiant heated sub floors.

NOTE: Area rugs placed over radiant heat slab will create heat retention in the floor. This may result in that area exceeding optimum temperature, and causing slightly larger gaps and minor distortions to the floor under the rugs.

Below Grade Installation

A concrete slab is considered below grade when any part of the slab is below ground level. For example, a basement with a walk out is considered below grade. A house cut into a hill is also considered to be below grade if it isn't properly graded to create a drainage swale on the lot. Below grade slabs must be carefully tested. Diligently follow all adhesive manufacturer's instructions for below grade installation.

Getting Started

1. Select Installation Type

ABOVE GRADE WOOD SUB FLOOR: Glue (Sheet with Baltic Birch plywood underlayment).

WOOD SUB FLOOR WITH CRAWL SPACE/ BASEMENT: Glue (Sheet with Baltic Birch plywood underlayment).

ON/ABOVE-GRADE CONCRETE: Glue (vapor abatement recommended for on grade installation).

BASEMENT: Glue with vapor abatement system.

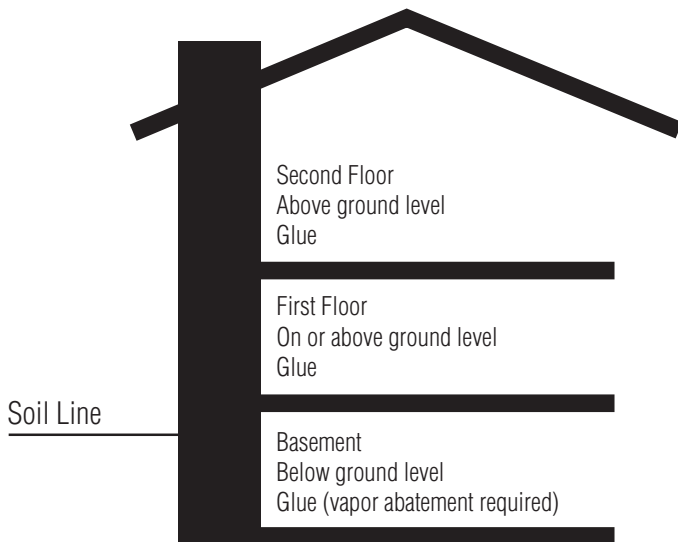

2. Cabinets & Appliances

Cabinets and built in appliances (sub-zero style refrigerators & dishwashers) should be installed prior to the installation of the luxury vinyl floor. Cabinets and built in appliances should not be installed on top of the floor. Installation of cabinets on top of glue down installation does not invalidate warranty. However, since this is not best practice, should the floor require repair under warranty, Hallmark Floors will not be liable for costs to remove and replace cabinets and or counter tops to effect repair. Luxury vinyl flooring should be installed at the same time as carpet and after the following: finishing walls, cabinet installation, appliance installation, tile & counter top installation. Standard refrigerators and kitchen oven/range are acceptable for placement on top of the luxury vinyl floor. Use caution when moving appliances by using a proper furniture dolly, air sled, 1/8" Masonite with glossy side down, or plastic glides designed for movement of heavy appliances. Failure to follow these precautions will damage the floor.

3. Undercut All Door Jambs/Moldings

Remove all shoe and base molding to ensure adequate expansion space. Use scrap piece of flooring to establish height of cut. Make allowances for adhesive or underlayment thickness when establishing height of cut.



4. Visual Inspection of Planks/Tiles

Visually inspect planks/tiles for any defects prior to installation. Verify that homeowner and/or end user has seen the product and approves proceeding with installation of the floor.



5. Open Multiple Boxes

Always work from multiple boxes simultaneously and blend the planks/tiles throughout the installation. This is especially important with mixed production dates. Hallmark has very good color consistency, and mixed production dates are acceptable for installation. Working from multiple boxes/production dates helps achieve a good blend of color.

6. Blend Boards to Moldings

Before you get started, open multiple boxes and check how the planks/tiles blend with the moldings. At beginning of installation, set aside those planks/tiles that best blend to the transition moldings on job.

7. Select a Starter Wall

When installing luxury vinyl, it is recommended to base the layout of the installation off of an exterior wall. Check to make sure the wall is straight and square to the room.

8. Starting Line

For starting row, cut blocks to use against side and end walls to maintain $\frac{1}{4}$ " minimum expansion space. Use spacers at both side the end of the rows. Use of adjustable spacers may be needed to help maintain a straight line.

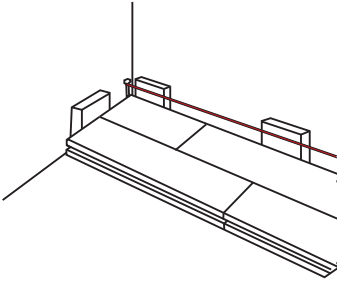

9. Irregular & Out-of-Square Walls

Scribe cut the first row to match variations in the wall. A scribe can be created by drilling a hole in a scrap piece of wood and inserting a pencil. The starting row can then be cut to compensate for an irregular wall or to help minimize the appearance of an out of square room by splitting the difference between the two walls.

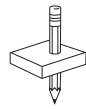

Glue Down Installation - Plank

2MM: PLank & Tile

3MM: Plank & Tile

Before installing any material, plan the layout of the plank end joints to avoid lining up on top of the sub floor/underlayment joints. Do not install plank end joints over expansion joints.

Installation Tools GLUE DOWN PLANK

Tape measure, pencil, chalk line, table saw, cut-off saw, vinyl guillotine, jamb saw, spacers, hammer, safety glasses, hearing protection, utility knife, specified notched trowel, wall spacers, straight edge, broom, speedy square, luxury vinyl floor cleaner, and shop vacuum.

NOTE: Hallmark Floors recommends pattern scribing, with utility knife or cutting with a power miter saw or vinyl guillotine cutter for cutting luxury vinyl plank.

10 GDP. Measure the Room

Accurately measure the room to determine the center line, and total width of the floor. The width can be divided by the width of the plank. This helps establish how many rows are required. The starting row and ending row can then be trimmed so the width of the starting plank and ending plank can be the same. Once this is known the starting row can be ripped to a narrower width if necessary, to give the floor balance.

11 GDP. Establish End Joint Pattern

Plank ends should be staggered, randomly to avoid a cluster or stair stepping of end joints. Varying the length of the starter plank will give the appropriate stagger for that row.

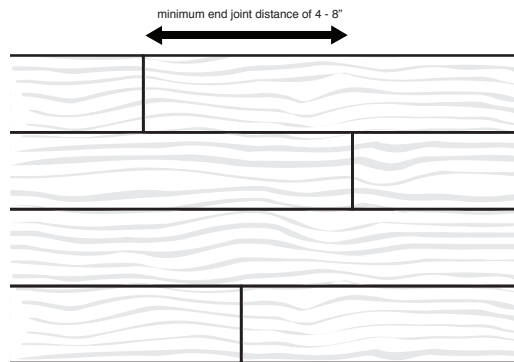

12 GDP. Starter Rows

Measure the equivalent of four to five rows, mark sub floor at both ends of run and snap a chalk line. Spread adhesive to chalk line. Repeat this process on all subsequent rows of material throughout the balance of installation. If starting from a center line, begin laying Hallmark Floors luxury vinyl flooring along the starting line and work back to the starting wall.

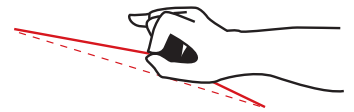
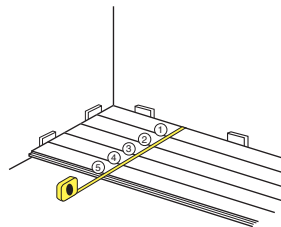

13 GDP. Set Planks

Spread adhesive and set plank into the adhesive while avoiding any movement of the plank. Clean up all adhesive residue from surface of floor as you proceed. Do not allow adhesive to dry on the surface of the planks.

14 GDP. Directional Installation

Ensure the planks are installed with the arrows imprinted on the back of the planks are laying in the same direction. If there are no arrows, the material is non-directional, and can be installed in either direction.

15 GDP. Roll Floor

After completion of the installation, the floor must be rolled with a minimum 100 lb. 3-section floor roller in both directions. Cover steel rollers with fresh duct tape before every use to prevent steel rollers damaging the surface of the floor.

16 GDP. Install Trim/Moldings

Cover all exposed areas. Use appropriate trim pieces along all walls, cabinets, etc. Use appropriate transition pieces in doorways or where Hallmark Floors luxury vinyl meets other flooring.

17 GDP. Clean Up

Remove all glue residue from the floor and vacuum up remaining debris.

Other than glue residue removal and vacuuming, do not clean the floor for 48 hours after installation. After 48 hours, use a damp mop with well-wrung-out sponge mop to remove residue and clean with Hallmark Trueclean.

ATTENTION!: Exposure to direct sunlight and other heat sources may affect the performance of the floor. Temporary paper shades/sheets over windows/glass doors can protect the floor surface from excessive heat and light. This will provide a measure of protection until permanent window coverings can be installed.

Glue Down Installation Tile

3MM: 18"x 18" tile

Before installing any material, plan the layout of the tile end joints to avoid lining up on top of the sub floor/underlayment joints. Do not install tile joints over expansion joints.

Installation Tools GLUE DOWN TILE

Tape measure, pencil, chalk line, table saw, vinyl guillotine, jamb saw, spacers, hammer, safety glasses, hearing protection, utility knife, specified notched trowel, wall spacers, straight edge, broom, speedy square, luxury vinyl floor cleaner, and shop vacuum.

NOTE: Hallmark Floors recommends pattern scribing with a utility knife or cutting with a power miter saw or vinyl guillotine cutter for cutting luxury vinyl tile.

10 GD. Center Point & Chalk Lines

Square tile cannot be installed using the same layout techniques as plank. Tile must begin from the center of the room. This will allow plenty of space to work outward to the walls to ensure a symmetrical pattern.

Establish the center point in the room by marking the center point of all four walls. Snap chalk lines between the center points of opposite walls. Make sure they're perfectly square and adjust as necessary.

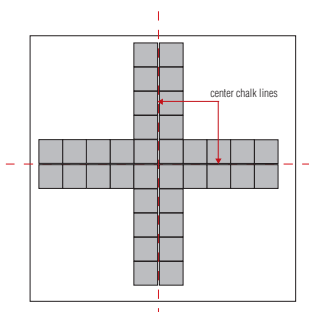

11 GD. Pattern Layout

Loose lay a row of tile along the center lines in both directions. If you have an unbalanced edge from one side to the other adjust your center line to maintain balance. Avoid having one edge with very thin tile and the other very wide. If using Polyurethane Grout, make sure you include spacers when planning the layout.

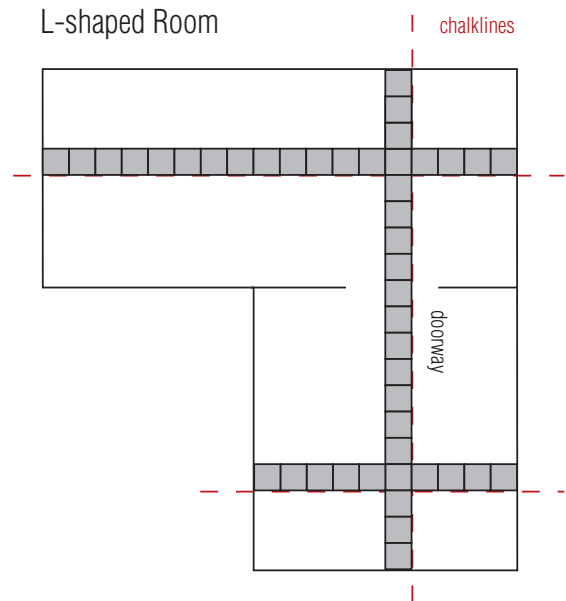

12 GD. Diagonal Pattern Layout

If installing tile on a 45° angle (diamond pattern), establish grid lines that allow the floor to be laid out in a balanced pattern.

NOTE: See Basic Pattern Section for more pattern options.

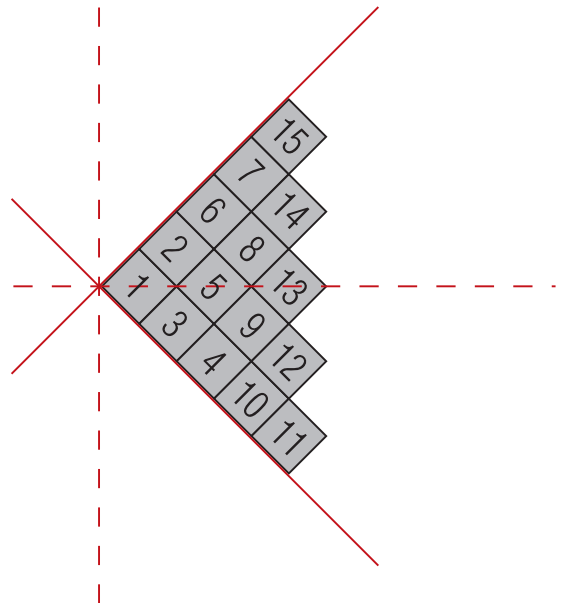

12 GD. Cutting Tiles

Tiles can be cut by pattern scribing with utility knife and snapping the tile, or by cutting with a vinyl guillotine cutter or table saw with a sharp, high tooth-count blade. (Tile is too wide to cut with chop saw).

13 GD. Set Tiles

Spread adhesive and set tile into the adhesive while avoiding any movement of the tile.

After installation has begun, begin laying Hallmark Floor luxury vinyl tiles along the starting lines and work out towards the surrounding walls.

Clean up all adhesive residue from surface of floor as you proceed. Do not allow adhesive to dry on the surface of the tiles.

14 GD. Roll Floor

After completion of the installation, the floor must be rolled with a minimum 100 lb. 3-section floor roller in both directions. Cover steel rollers with fresh duct tape before every use to prevent steel rollers damaging the surface of the floor.

15 GD. Install Trim/Moldings

Cover all exposed areas. Use appropriate trim pieces along all walls, cabinets, etc. Use appropriate transition pieces in doorways or where Hallmark Floors luxury vinyl meets other flooring.

16 GD. Clean Up

Remove all glue residue from the floor and vacuum up remaining debris.

Other than glue residue removal and vacuuming, do not clean the floor for 48 hours after installation. After 48 hours, use a damp mop with well-wrung-out sponge mop to remove residue and clean with Hallmark Trueclean.

ATTENTION!: Exposure to direct sunlight and other heat sources may affect the performance of the floor. Temporary paper shades/sheets over windows/glass doors can protect the floor surface from excessive heat and light. This will provide a measure of protection until permanent window coverings can be installed.

18" x 18" and 18" x 36" Basic Patterns Tile

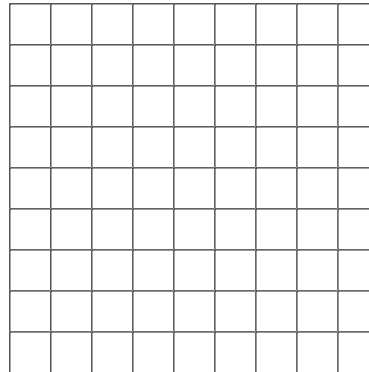

Checker Board

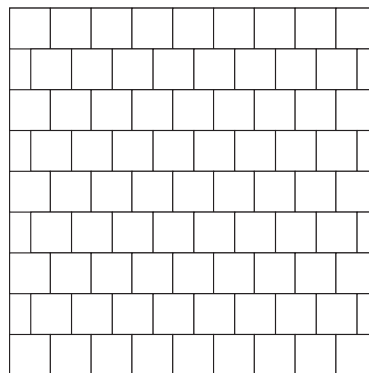

Brick

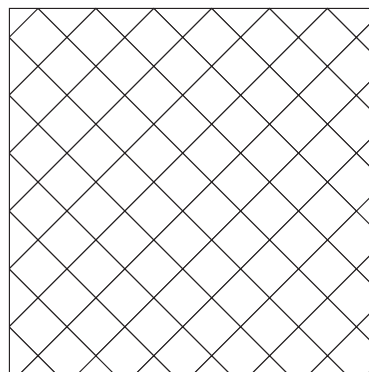

Checker Board 45°

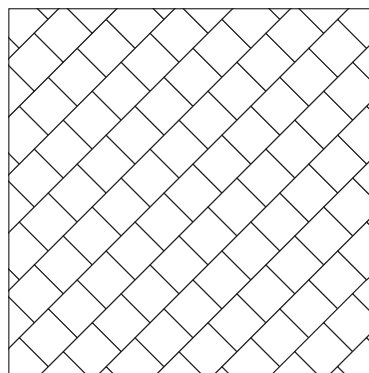

Brick 45°

Glue Down Installation 18" x 18" or 18" x 36" Vinyl Tile

3MM: 18"x36" tile

Note: Proper layout is critical to the performance and appearance of the product.

Before installing any material, plan the layout of the tile end joints to avoid lining up on top of the sub floor/underlayment joints. Do not install tile joints over expansion joints.

Installation Tools GLUE DOWN TILE

Tape measure, pencil, chalk line, table saw, vinyl guillotine, jamb saw, spacers, hammer, safety glasses, hearing protection, utility knife, specified notched trowel, wall spacers, straight edge, broom, speedy square, luxury vinyl floor cleaner, and shop vacuum.

NOTE: Hallmark Floors recommends pattern scribing, with utility knife or cutting with a power miter saw or vinyl guillotine cutter for cutting luxury vinyl tile

10 GDT. Center Point & Chalk Lines

Rectangular tile cannot be installed using the same layout techniques as plank. Tile must begin from the center of the room. This will allow plenty of space to work outward to the walls to ensure a symmetrical pattern.

Establish the center point in the room by marking the center point of all four walls. Snap chalk lines between the center points of opposite walls. Make sure they're perfectly square and adjust as necessary.

11 GDT. Pattern Layout

Loose lay a row of tile along the center lines in both directions. If you have an unbalanced edge from one side to the other adjust your center line to maintain balance. Avoid having one edge with very thin tile and the other very wide. If using polyurethane grout make sure you include spacers when planning the layout. Rectangular tile has many options for installation layout. Ensure you are familiar/experienced with these types of installation as chalk layout lines will have to be used to ensure the pattern does not drift. 18" x 36" tiles are large format, and some patterns may not be suitable for smaller rooms. Dry lay a small portion of the pattern or graph out room size on paper.

The starting point in a modular installation must be as close to the center of the room as possible and must be positioned to center the pattern in the room. Snap a chalk line parallel to one major wall bisecting the starting point. It may be necessary to offset the center chalk line to assure perimeter modules will be at least half size.

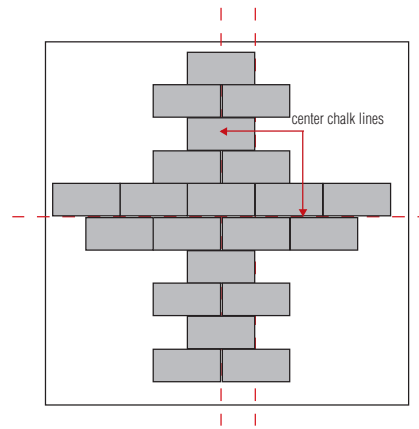

L-shaped Room

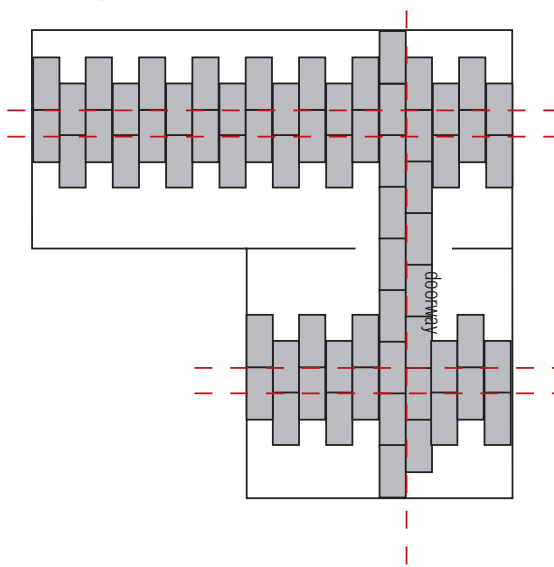

12 GDT. Diagonal Patterns

If installing tile on a 45° angle, establish grid lines that allow the floor to be laid out in a balanced pattern.

NOTE: See Basic Pattern Section for more pattern options.

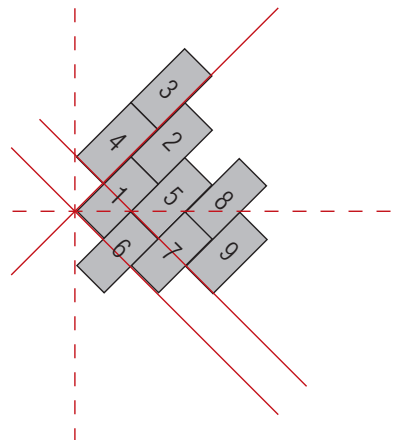

12 GDT. Cutting Tiles

Tiles can be cut by pattern scribing with utility knife and snapping the tile, or by cutting with a vinyl guillotine cutter or table saw with a sharp, high tooth-count blade. (Tile is too wide to cut with chop saw).

13 GDT. Set Tiles

Spread adhesive and set tile into the adhesive while avoiding any movement of the tile.

After installation has begun, begin laying Hallmark Floor luxury vinyl tiles along the starting lines and work out towards the surrounding walls.

Clean up all adhesive residue from surface of floor as you proceed. Do not allow adhesive to dry on the surface of the tiles.

14 GDT. Roll Floor

After completion of the installation, the floor must be rolled with a minimum

100 lb. 3-section floor roller in both directions. Cover steel rollers with fresh duct tape before every use to prevent steel rollers damaging the surface of the floor.

15 GDT. Install Trim/Moldings

Cover all exposed areas. Use appropriate trim pieces along all walls, cabinets, etc. Use appropriate transition pieces in doorways or where Hallmark Floors luxury vinyl meets other flooring.

16 GDT. Clean Up

Do not clean the floor for 48 hours after installation.

After 48 hours, use a damp mop with well-wrung-out sponge mop to remove residue and clean with Hallmark Trueclean.

ATTENTION!: Exposure to direct sunlight and other heat sources may affect the performance of the floor. Temporary paper shades/sheets over windows/glass doors can protect the floor surface from excessive heat and light. This will provide a measure of protection until permanent window coverings can be installed.

18" x 36" Basic Patterns

Rectangular Tile

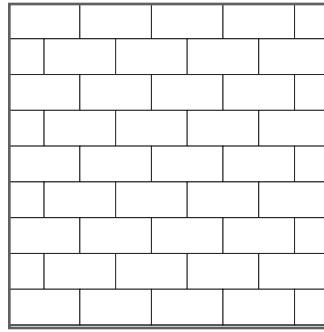

Brick

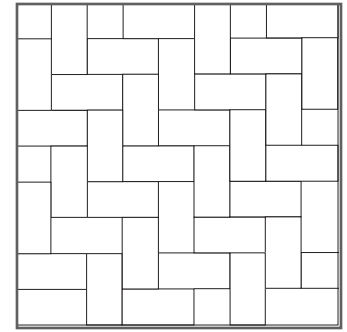

Herringbone 90°

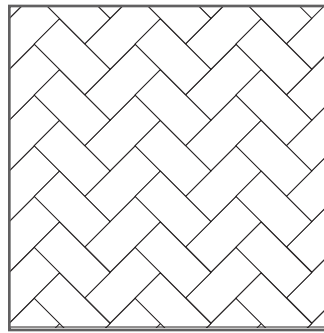

Herringbone 45°

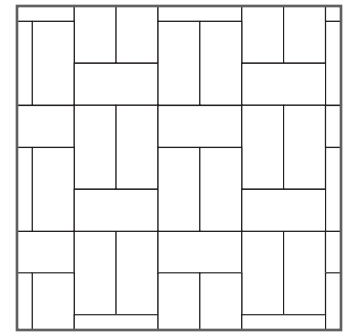

Single Basket Weave

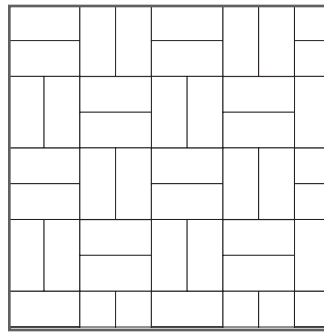

Double Basket Weave

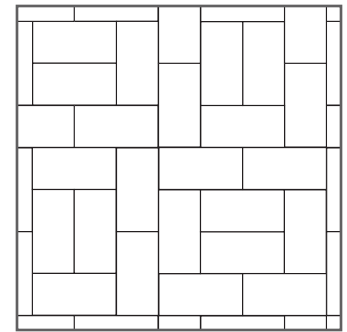

Wrapped Basket Weave

18" x 36" Pattern Setup

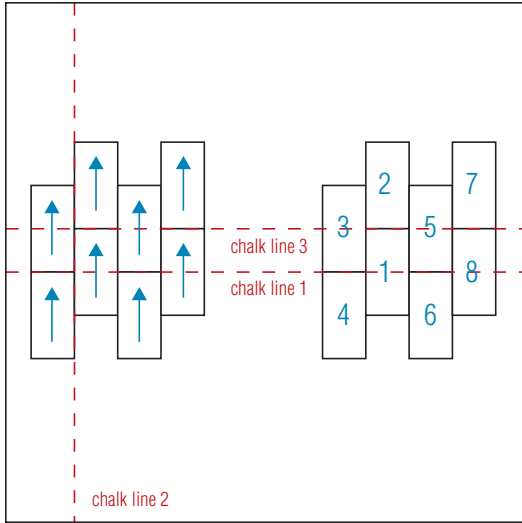

Brick

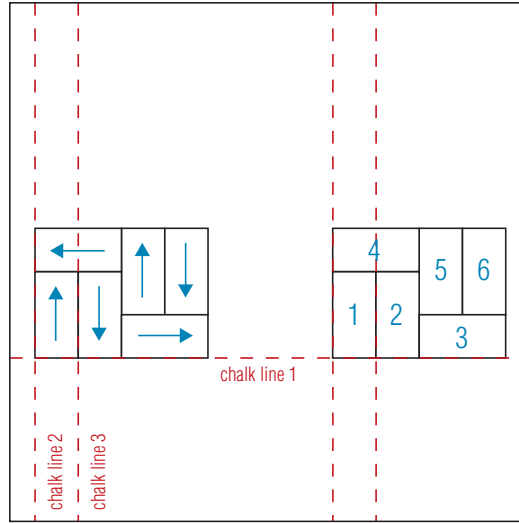

Single Basket Weave

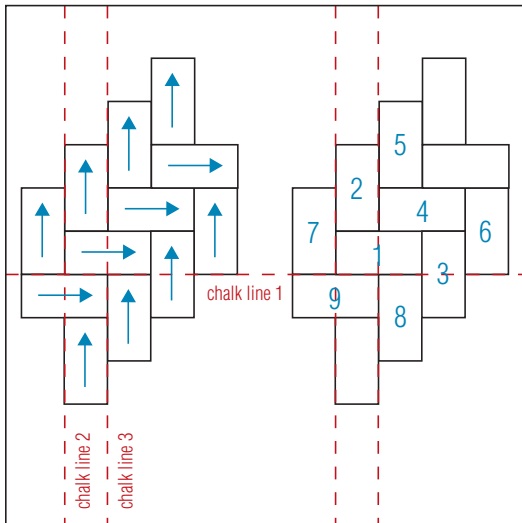

Herringbone 90°

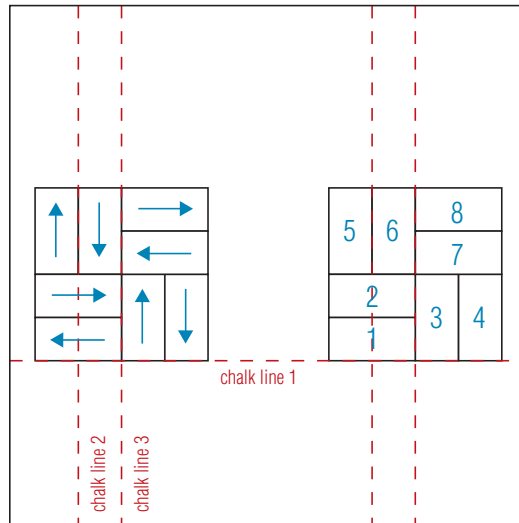

Double Basket Weave

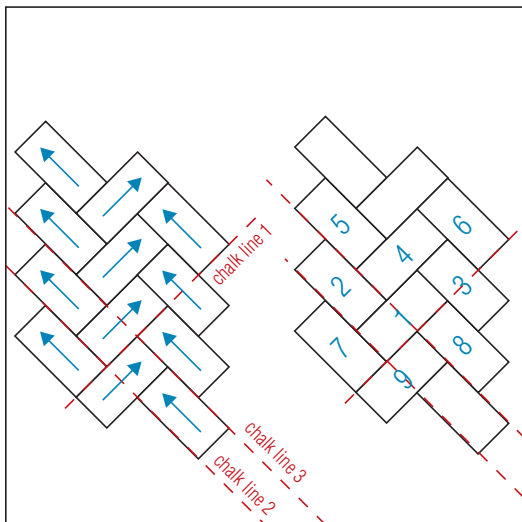

Herringbone 45°

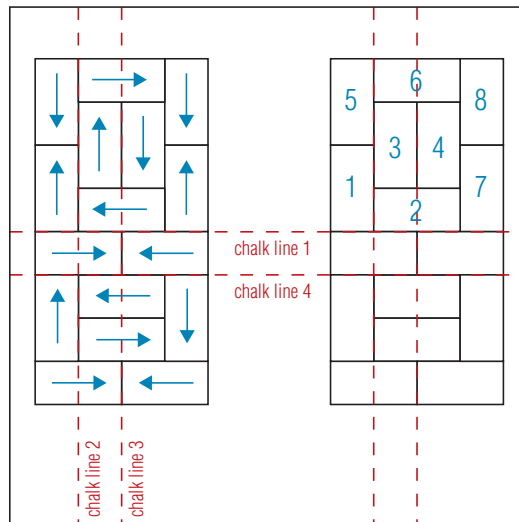

Wrapped Basket Weave

